



SHENZHEN FENDA TECHNOLOGY CO.,LTD.,GUANGDONG,PRC
ADD: Fenda Hi-Tech Park, Zhoushi Road, Shiyan, Baoan, Shenzhen, Guangdong, PRC
Tel: +86-755-27486668 (800 line) Fax: +86-755-27486663 P.C.: 518108

F&D
www.fenda.com



F210X User Manual

2.1 Computer Multimedia Speaker

CAUTION:

- Do not place the system in the high-temp and humid environment, prevent it from raining or rough handling and strong shock.
- In order to avoid electric shock and other accidents, do not open the right side panel cover for repair without any professional guidance.
- In case fragments or other liquids is accidentally sprinkled inside the cabinet, please switch off the power immediately. In case of repair pls Come to the professional maintenance for help.
- Switch off the power and take off the plug from the power jack when the system is not on work.
- Keep it safe from water drops or splashing water, and no liquid container allowed to be put on its top side.
- Keep the cabinet vent far from the wall by 20mm at least and the air vent should not be blocked.
Do not keep it close to the fire.

FEATURES:

- Seamlessly stream music from your iPad, iPhone, Android device, laptop or other Bluetooth-enabled devices. No wires means your mobile devices stay mobile.
- USB connectivity allows you to play your entire music collection with click of a button.
- Built-in OCL Amplifier, super-bass design for subwoofer and with the output of 3 channel.
- Supporting Bluetooth protocol V2.1+EDR and A2DP1.2 audio streaming profile.
- Powerful and perfect transformer to assure transforming efficiency and strong power output.
- Adaptable to any equipments with audio system such as PC, VCD, DVD, LCD & TV etc.

SYSTEM COMPOSITION:

- | | | | |
|------------------------------|------|-----------------------------|-----|
| • Subwoofer unit | 1pc | • Operation manual | 1pc |
| • Plastic satellite speakers | 2pcs | • Warranty card | 1pc |
| • Remote control | 1pc | • 3.5mm to RCA stereo cable | 1pc |

INSTALLATION GUIDE: (See the below guiding pictures)

1. Connect the satellite speaker cable to the output port of subwoofer in respective color port
2. Insert Input signal cable (RCA Socket) into subwoofer input port and the other end with output port of your Audio/Video system in respective color port.

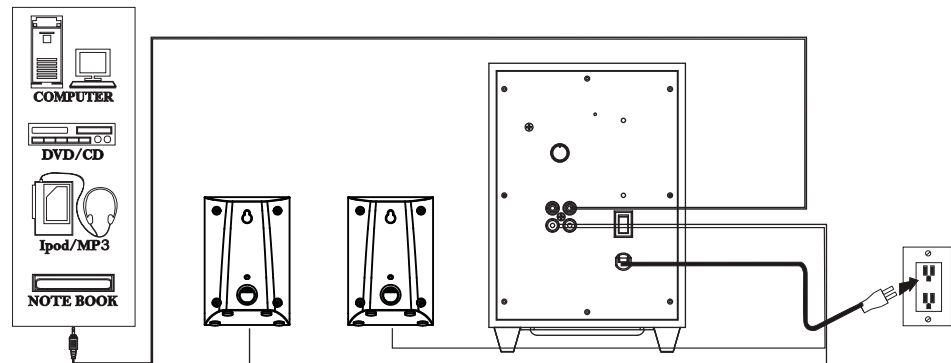

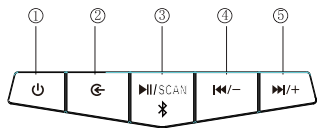
Front panel keys

1. Standby button
2. Source button
3. Play/Pause/FM auto scan/Bluetooth button
4. Previous button and Volume decrease
5. Next button and Volume increase

Function of Panel keys

- A. : Turn on/off unit.
- B. : Switch between BT, AUX, USB and FM mode.
- C.
 - a. USB Mode: short press for play/pause music.
 - b. FM Mode: Short press to start Auto Search & this will store the found frequencies (channels) automatically.
 - c. Bluetooth mode: long press entering pairing mode ,display will flash fast .short press to play/pause music.
- D.
 - a. USB mode: Short press to decrease volume,long press to select previous song.
 - b. FM mode: Short press to decrease volume,long press to select previous stored station.
 - c. Bluetooth mode: Short press to decrease volume,long press to select previous song.
- F.
 - a. USB mode: Short press to increase volume,long press to select next song.
 - b. FM mode:Short press to increase volume,long press to select next stored station.
 - c. Bluetooth mode: Short press to increase volume,long press to select next song.

LED indicator:Blue for Bluetooth,Purple for FM, Green for USB,White for AUX and Red for standby.

Remote control

Remote control keys function

- A. : turn on/off unit.
- B. AUX,Bluetooth ,USB (For USB Mode) and FM key: short press the keys to switch to respective modes.
- C. : press it to mute or unmute the sound.
- D. : decrease or increase master volume.
- E. Tune+/-: FM mode:
 - Fine Tuning: Short press to increase or decrease one step (100Khz), FM LED flash once. LED stop flashing once it reaches to Minimum or Maximum frequency. Manual Tuning: Long press of this key works for Manual tuning,It finds the next available frequency.
- F. MEM: Short press of this key work to store tuned station through Fine or Manual tuning. FM LED flash once to indicate store/save operation.
- G. CH+/-: select stored station.
- H. Scan: FM mode: Short press to start Auto Search & this will store the found frequencies (channels) automatically.
- I. Enter: confirm setting and return to main screen.
- J. 0~9 number keys:
 1. USB source: directly press numeric keys through remote to select your favorite song if you know the song number in the folder.The system will automatically play the last song of the folder if you press number excess of song number of that folder.

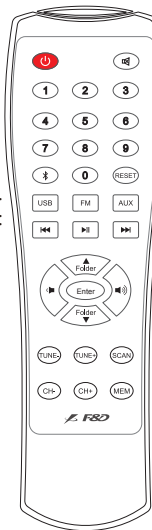

2. FM source: directly press numeric keys through remote to select your favorite station if you know the station number (1~100). Or press 3 or 4 digits of frequency to play that station, for example, 1026 for 102.6 MHz station.

K.  : USB and BT source, short press to play or pause.

L.  : USB and BT source, short press to select previous song.

M.  : USB and BT source, short press to select next song.

N. Folder  /  : USB source, short press to select next/previous folder.

O.  :short press to Bluetooth mode and Long press entering pairing mode,blue LED will flash fast.

P. Reset: short press to go to default settings.

Notice: After switch to Bluetooth source,the unit will automatically search the Bluetooth device and connect it. If the device paired before. If can't find paired device,it will enter pairing mode automatically and the blue LED will flash quickly. Bluetooth device should active "Bluetooth" function during pairing and search for "Fenda F210X" .

Specifications

Output power(RMS): 3WX2+9W

Speaker unit:

Full Range Speaker: 2.5", 4(Ω) , Subwoofer:4", 4(Ω)

Frequency response:

Subwoofer: 30HZ-130HZ

Satellite: 150HZ-20KHZ

Power supply:220-240V~50Hz/60Hz 0.1A

Signal input:RCA jack

S/N Ratio:≥60dB

Separation:≥40dB

Unit size:

Subwoofer: W160xD220xH215mm

Satellite: W87xD80xH132mm

Net Weight: 2.8Kg

Compatibility:

Compatible with Smartphones and tablets supporting Bluetooth (A2DP) protocol

Troubleshooting

Problem	Possible Cause	Solution
F&D system does not turn on	Power cable not connected to the power outlet and/or F&D System	Check connection
Sound reproduction too soft	Volume of F&D System set too low	increase the volume using the "Volume" button. increase the volume of the source device
F&D System does not respond to remote control.	The battery is empty	Replace battery, observe correct polarity at insertion
No sound reproduction	Source device not producing any signal.	Digital output on the source device not activated
	Cable not correctly connected/faulty cable.	Check the connection of the source device to the F&D System and change the cable if necessary.
	Distance is far from device in Bluetooth mode	put your Bluetooth device close to the speaker
	Bluetooth device not connected successfully	please restart the speaker and try again

WARRANTY CARD

END-USER'S COPY

WARRANTY REGISTRATION CERTIFICATE

Mr./Mrs/Ms First Name: _____

Last Name: _____

Address: _____

Contact No.: _____

Product Name: _____

Model No.: _____

Serial No.: _____

Date Purchased: _____

Invoice No.: _____

Retail Outlet Where Purchased: _____



(Please print the name & address)

SECTION 1

WARRANTY TERMS & CONDITIONS

The warranty will be effective only if the warranty card is completed and returned to the company within 14 days from the date of purchase. We guarantee the provision of free services of  product within the warranty period from its date of purchase from our Authorised Dealer.

The period and conditions of our warranty service are as follow:

1. The warranty covers services by our  Authorised Dealer. This warranty card together with the receipt must be presented when servicing is required. This warranty card is irreplaceable in the event of loss.
2. Repair services will be provided for defects arising from normal usage for the following period, commencing from the date of purchase from our  Authorised Dealer. (Parts would be replaced when necessary)
 - A. Parts:..... 1 year
 - B. Technical service free..... 1 year
3. Under the following circumstances, service and parts will be chargeable even within the warranty period:
 - A. Failure to present the warranty card and receipt when servicing is required.
Full particulars not clearly shown or alterations made against the actual information.
For e.g.: Alteration of the date of purchase, serial numbers-altered or removed.
 - B. This unit being tampered with, altered in any way by any unauthorised technicians or which has been subjected to misuse, negligence or accident. This guarantee does not cover damage occurring in transit by or from the customer.
 - C. The defect is caused by the attack of household pests, fire, lighting, natural disasters, pollution, abnormal voltage or the usage of generator.

Shenzhen Fenda Technology Co., Ltd.
Add : Fenda Hi-Tech Park, Zhoushi Road, Shiyan, Baoan, Shenzhen, China
P.C. : 518108 [Http://www.fenda.com](http://www.fenda.com)

WARRANTY CARD

DISTRIBUTOR'S COPY

WARRANTY REGISTRATION CERTIFICATE

Mr./Mrs/Ms First Name: _____

Last Name: _____

Address: _____

Contact No.: _____

Product Name: _____

Model No.: _____

Serial No.: _____

Date Purchased: _____

Invoice No.: _____

Retail Outlet Where Purchased: _____



(Please print the name & address)

SECTION 2

WARRANTY TERMS & CONDITIONS

The warranty will be effective only if the warranty card is completed and returned to the company within 14 days from the date of purchase. We guarantee the provision of free services of  product within the warranty period from its date of purchase from our Authorised Dealer.

The period and conditions of our warranty service are as follow:

1. The warranty covers services by our  Authorised Dealer. This warranty card together with the receipt must be presented when servicing is required. This warranty card is irreplaceable in the event of loss.
2. Repair services will be provided for defects arising from normal usage for the following period, commencing from the date of purchase from our  Authorised Dealer. (Parts would be replaced when necessary)
 - A. Parts:..... 1 year
 - B. Technical service free..... 1 year
3. Under the following circumstances, service and parts will be chargeable even within the warranty period:
 - A. Failure to present the warranty card and receipt when servicing is required.
Full particulars not clearly shown or alterations made against the actual information.
For e.g.: Alteration of the date of purchase, serial numbers-altered or removed.
 - B. This unit being tampered with, altered in any way by any unauthorised technicians or which has been subjected to misuse, negligence or accident. This guarantee does not cover damage occurring in transit by or from the customer.
 - C. The defect is caused by the attack of household pests, fire, lighting, natural disasters, pollution, abnormal voltage or the usage of generator.

Shenzhen Fenda Technology Co., Ltd.
Add : Fenda Hi-Tech Park, Zhoushi Road, Shiyan, Baoan, Shenzhen, China
P.C. : 518108 [Http://www.fenda.com](http://www.fenda.com)